

P30

workshop tool trolley
with 706 tools for 9 drawers
830.9706

WANT TO GO INTO MORE DETAIL?

P30



Workshop trolley P30
with 8 compartments
873.4008

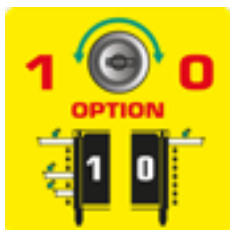

DUO Lock Brilliant
locking system



8 Drawers each
load capacity up to 50 kg



Stable
ball bearing



Stainless steel surface

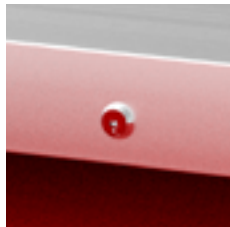

Lock
lockable

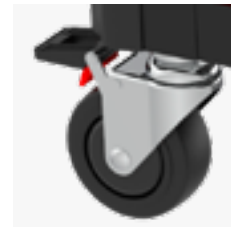

Anti-static castors
with brakes



Integrated
corner protection



Paper roll holder
included



Can holder
included

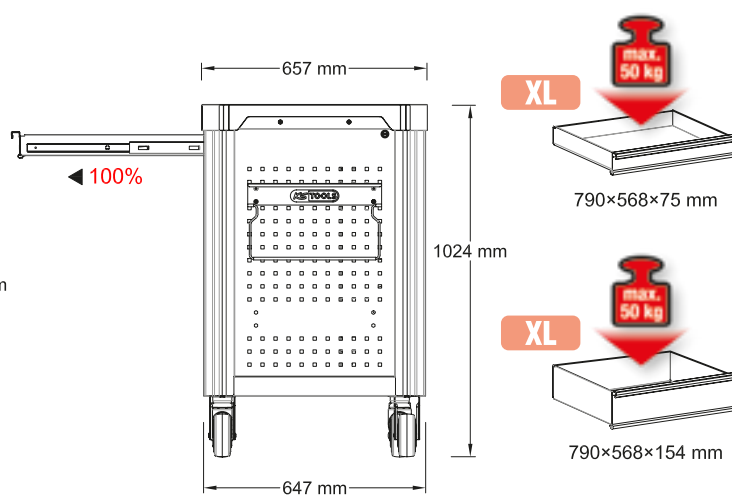
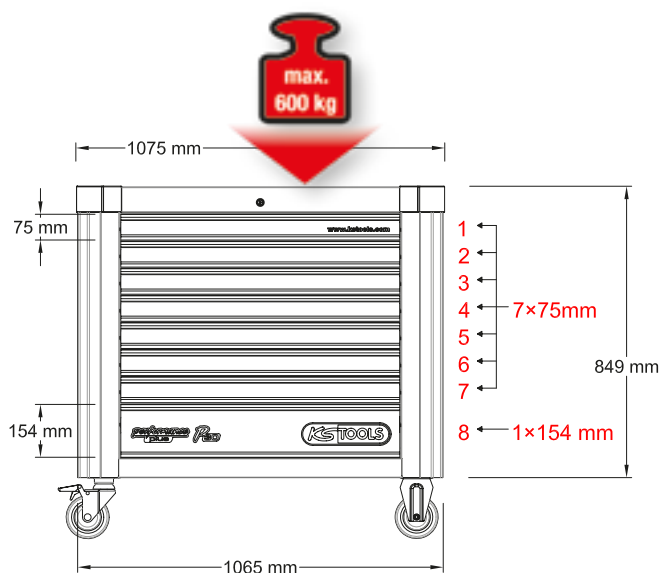

P30 workshop tool trolley set with 706 tools for 7 drawers

830.9706



5 6 8 9



1 2 3 4 7

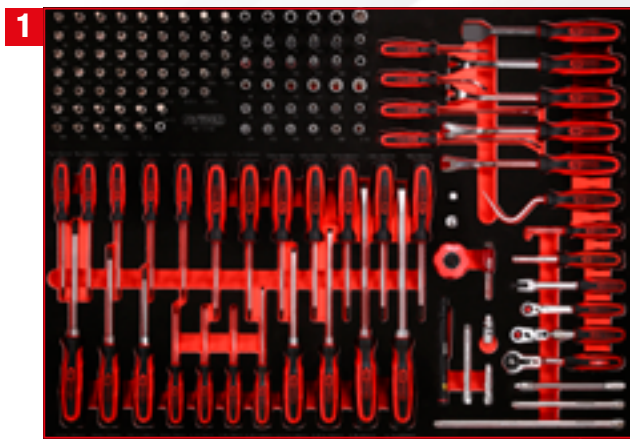

1/4" socket spanner and
screwdriver set

821.0142

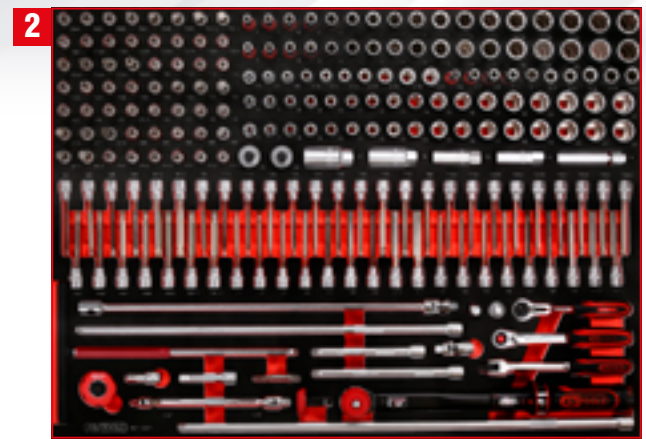

3/8" socket spanner set
in foam insert

821.0221



1/2" socket spanner set
in foam insert

821.0149



Screw spanner set in
foam insert

821.0076



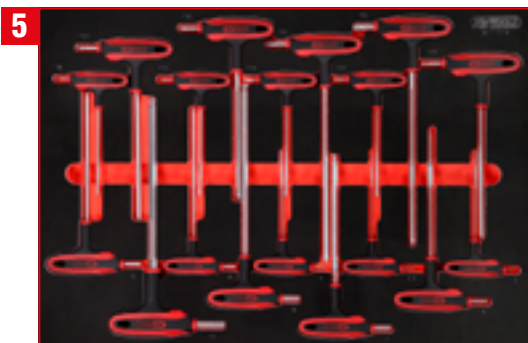

1 PCS
18

T-handle angle spanner set in foam insert

811.1018



1 PCS
18

T-handle angle spanner set in foam insert

811.2018



1 PCS
34

Spanner set in foam insert

821.0034



1 PCS
20

Hammer and chisel set in foam insert

811.0020



1 PCS
28

Measuring tool and file set in foam insert

811.0028

XL 1/4" Socket spanner and screwdriver set

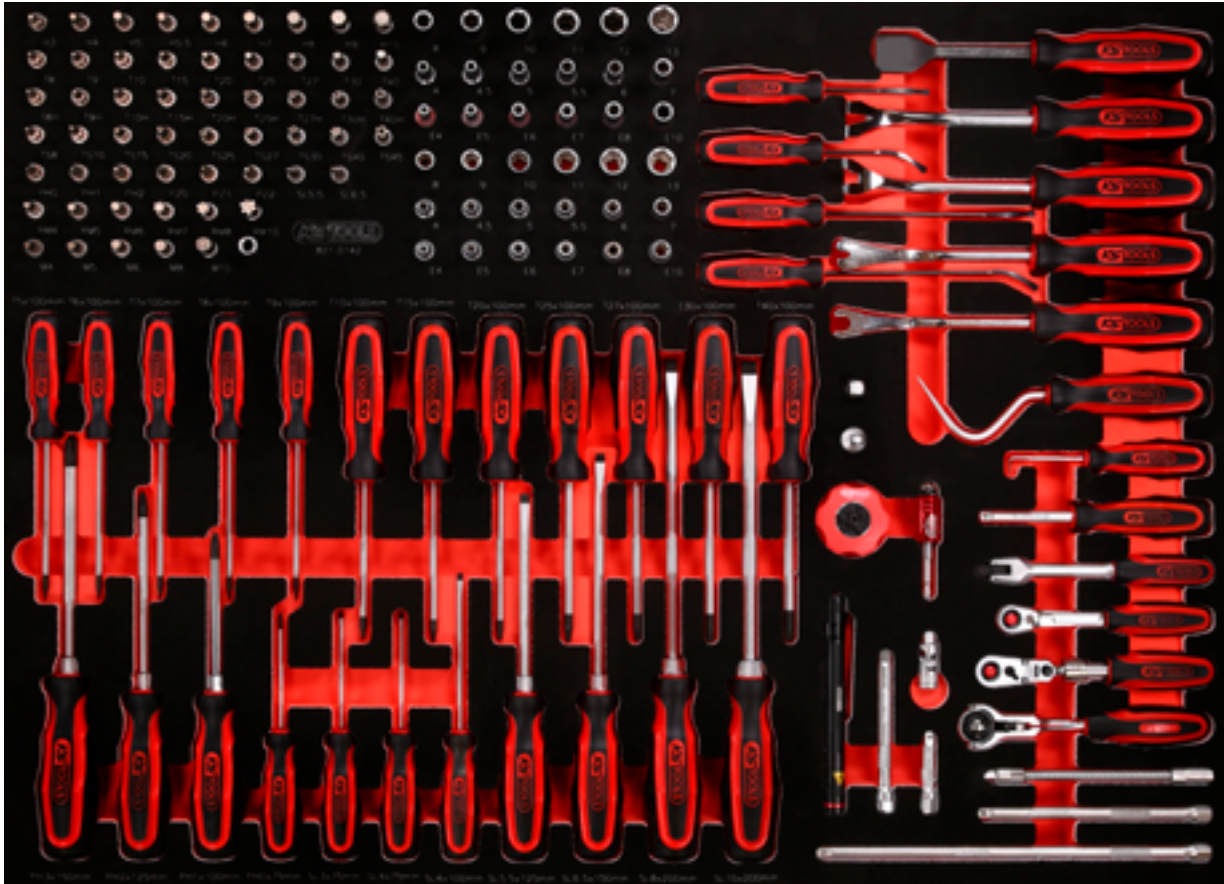

Pos.	Code	Description	pcs	Pos.	Code	Description	pcs	Pos.	Code	Description	pcs
1	911.1436	1/4" Bit socket hexagon, 3 mm	1	27	911.1468	TX bit socket tamperproof, 1/4", TB40	1	54	917.1545	1/4" Bit socket spline (XZN), M8	1
2	911.1437	1/4" Bit socket hexagon, 4 mm	1	28	917.1578	1/4" Torx Plus Bit-Socket 8IPR	1	55	917.1546	1/4" Bit socket spline (XZN), M10	1
3	911.1438	1/4" Bit socket hexagon, 5 mm	1	29	911.1701	1/4" Bit socket five star tamperproof, TS10	1	56	911.0101	1/4" socket with magnet	1
4	911.14385	1/4" Bit socket hexagon, 5,5 mm	1	30	911.1702	1/4" Bit socket five star tamperproof, TS15	1	57	917.1428	1/4" Hexagonal socket, deep, 8 mm	1
5	911.1439	1/4" Bit socket hexagon, 6 mm	1	31	911.1703	1/4" Bit socket five star tamperproof, TS20	1	58	917.1429	1/4" Hexagonal socket, deep, 9 mm	1
6	911.1440	1/4" Bit socket hexagon, 7 mm	1	32	911.1704	1/4" Bit socket five star tamperproof, TS25	1	59	917.1430	1/4" Hexagonal socket, deep, 10 mm	1
7	911.1441	1/4" Bit socket hexagon, 8 mm	1	33	911.1705	1/4" Bit socket five star tamperproof, TS27	1	60	917.1431	1/4" Hexagonal socket, deep, 11 mm	1
8	917.1454	1/4" Bit socket hexagon, 9 mm	1	34	911.1706	1/4" Bit socket five star tamperproof, TS30	1	61	917.1432	1/4" Hexagonal socket, deep, 12 mm	1
9	917.1452	1/4" Bit socket hexagon, 10 mm	1	35	911.1707	1/4" Bit socket five star tamperproof, TS40	1	62	917.1433	1/4" Hexagonal socket, deep, 13 mm	1
10	911.1448	1/4" Bit socket Torx, T8	1	36	911.1708	1/4" Bit socket five star tamperproof, TS45	1	63	917.1525	1/4" Hexagonal socket, deep, 4 mm	1
11	911.1478	1/4" Bit socket Torx, T9	1	37	911.1482	1/4" Bit socket, PH0	1	64	917.1526	1/4" Hexagonal socket, deep, 4,5 mm	1
12	911.1442	1/4" Bit socket Torx, T10	1	38	911.1415	1/4" Bit socket, PH1	1	65	917.1527	1/4" Hexagonal socket, deep, 5 mm	1
13	911.1443	1/4" Bit socket Torx, T15	1	39	911.1416	1/4" Bit socket, PH2	1	66	917.1528	1/4" Hexagonal socket, deep, 5,5 mm	1
14	911.1444	1/4" Bit socket Torx, T20	1	40	911.1483	1/4" Bit socket, PZ0	1	67	917.1426	1/4" Hexagonal socket, deep, 6 mm	1
15	911.1445	1/4" Bit socket Torx, T25	1	41	911.1401	1/4" Bit socket, PZ1	1	68	917.1427	1/4" Hexagonal socket, deep, 7 mm	1
16	911.1449	1/4" Bit socket Torx, T27	1	42	911.1402	1/4" Bit socket, PZ2	1	69	917.2401	1/4 Torx E Socket, deep E4	1
17	911.1446	1/4" Bit socket Torx, T30	1	43	911.1419	1/4" Bit socket slot, 5,5 mm	1	70	917.2402	1/4 Torx E Socket, deep E5	1
18	911.1447	1/4" Bit socket Torx, T40	1	44	917.1421	1/4" Bit socket slot, 6,5 mm	1	71	917.2403	1/4 Torx E Socket, deep E6	1
19	911.1461	TX bit socket tamperproof, 1/4", TB8	1	45	917.1584	1/4" RIBE Socket M4S	1	72	917.2404	1/4 Torx E Socket, deep E7	1
20	911.1485	TX bit socket tamperproof, 1/4", TB9	1	46	917.1585	1/4" RIBE Socket M5S	1	73	917.2405	1/4 Torx E Socket, deep E8	1
21	911.1462	TX bit socket tamperproof, 1/4", TB10	1	47	917.1586	1/4" RIBE Socket M6S	1	74	917.2406	1/4 Torx E Socket, deep E10	1
22	911.1463	TX bit socket tamperproof, 1/4", TB15	1	48	917.1587	1/4" RIBE Socket M7S	1	75	917.1408	1/4" Hexagonal socket, 8 mm	1
23	911.1464	TX bit socket tamperproof, 1/4", TB20	1	49	917.1588	1/4" RIBE Socket M8S	1	76	917.1409	1/4" Hexagonal socket, 9 mm	1
24	911.1465	TX bit socket tamperproof, 1/4", TB25	1	50	917.1590	1/4" RIBE Socket M10S	1	77	917.1410	1/4" Hexagonal socket, 10 mm	1
25	911.1466	TX bit socket tamperproof, 1/4", TB27	1	51	917.1541	1/4" Bit socket spline (XZN), M4	1	78	917.1411	1/4" Hexagonal socket, 11 mm	1
26	911.1467	TX bit socket tamperproof, 1/4", TB30	1	52	917.1542	1/4" Bit socket spline (XZN), M5	1	79	917.1412	1/4" Hexagonal socket, 12 mm	1
				53	917.1543	1/4" Bit socket spline (XZN), M6	1	80	917.1413	1/4" Hexagonal socket, 13 mm	1

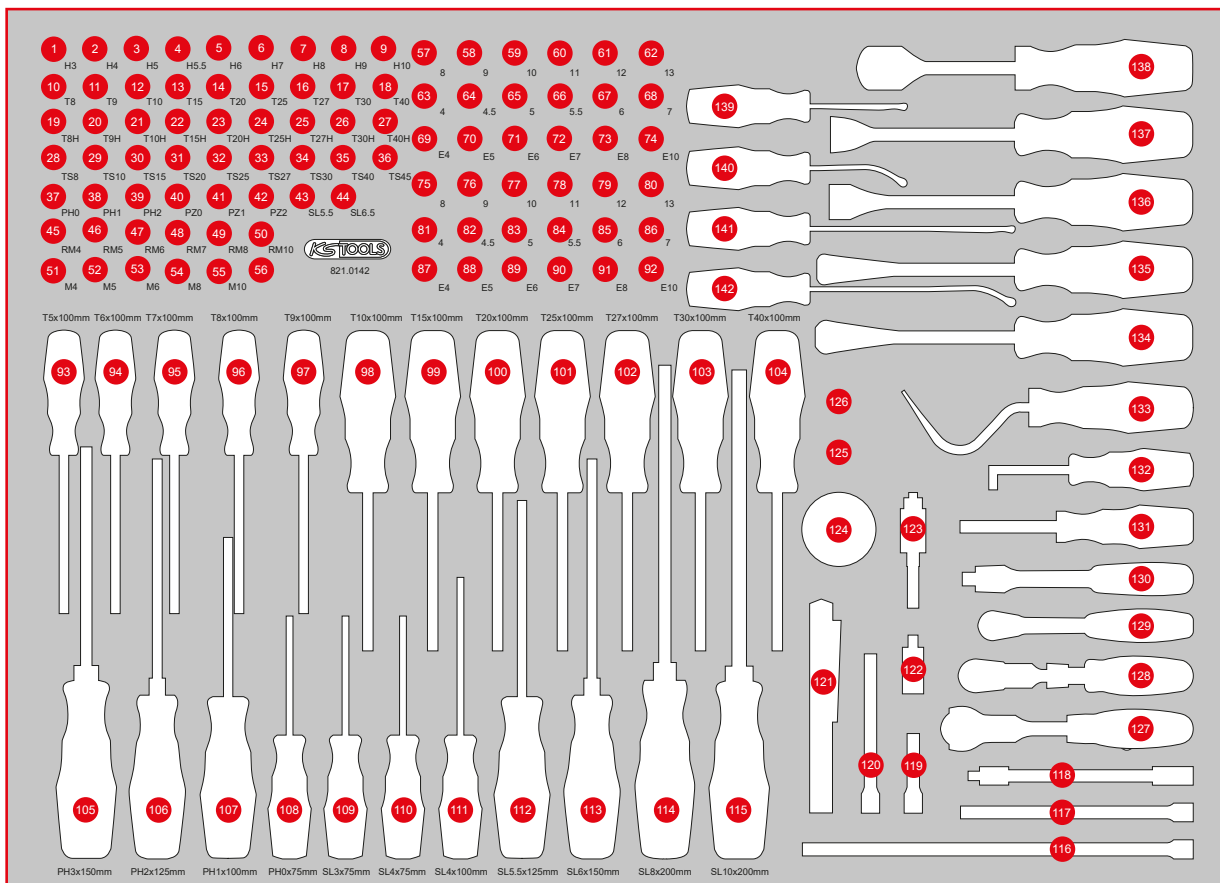

Pos.	Code	Description	pcs	Pos.	Code	Description	pcs	Pos.	Code	Description	pcs
81	917.1404	1/4" Hexagonal socket, 4 mm	1	107	159.1029	ERGOTORQUEplus screwdriver for screws PH1, L = 205 mm	1	127	914.1405	1/4" MODIFIX mini T-handle swivel head ratchet, 72 teeth	1
82	917.14045	1/4" Hexagonal socket, 4,5 mm	1	108	159.1027	ERGOTORQUEplus screwdriver for screws PH0, L = 155 mm	1	128	914.1420	1/4" SlimPOWER telescopic-joint reversible ratchet, 72 teeth	1
83	917.1405	1/4" Hexagonal socket, 5 mm	1	109	159.1002	ERGOTORQUEplus screwdriver for slotted screws, 3 mm, L = 155 mm	1	129	920.1490	1/4" SlimPOWER Reversible ratchet, 72 teeth	1
84	917.14055	1/4" Hexagonal socket, 5,5 mm	1	110	159.1003	ERGOTORQUEplus screwdriver for slotted screws, 4 mm, L = 155 mm	1	130	917.1488	1/4" Flexi head drive handle	1
85	917.1406	1/4" Hexagonal socket, 6 mm	1	111	159.1004	ERGOTORQUEplus screwdriver for slotted screws, 4 mm, L = 180 mm	1	131	911.1434	1/4" Square drive screwdriver, 150 mm	1
86	917.1407	1/4" Hexagonal socket, 7 mm	1	112	159.1006	ERGOTORQUEplus screwdriver for slotted screws, 5,5 mm, L = 230 mm	1	132	550.1048	Hook, 90° offset	1
87	911.4313	1/4" Torx E Socket, E4	1	113	159.1009	ERGOTORQUEplus screwdriver for slotted screws, 6,5 mm, L = 255 mm	1	133	550.1073	Hook, large, sickle	1
88	911.4314	1/4" Torx E Socket, E5	1	114	159.1011	ERGOTORQUEplus screwdriver for slotted screws, 8 mm, L = 315 mm	1	134	140.2373	Clip remover short, length 245 mm, opening 10 mm	1
89	911.4315	1/4" Torx E Socket, E6	1	115	159.1012	ERGOTORQUEplus screwdriver for slotted screws, 10 mm, L = 315 mm	1	135	140.2371	Clip remover short, length 245 mm, opening 4 mm	1
90	911.4316	1/4" Torx E Socket, E7	1	116	911.1504	1/4" Extension with hexagon drive, 250 mm	1	136	140.2615	Clip remover, short 9 mm	1
91	911.4317	1/4" Torx E Socket, E8	1	117	911.1451	1/4" Extension with hexagon drive, 150 mm	1	137	140.2616	Clip remover, short 7,5 mm	1
92	911.4332	1/4" Torx E Socket, E10	1	118	911.1422	1/4" Flexible Extensions, 150 mm	1	138	907.2222	Gasket scraper, 25 x 200 mm	1
93	159.1133	ERGOTORQUEplus screwdriver, Torx T5	1	119	911.1423	1/4" Extension with hexagon drive, 50 mm	1	139	140.2613	Panel lever 3 x 63 mm, bent	1
94	159.1134	ERGOTORQUEplus screwdriver, Torx T6	1	120	911.1424	1/4" Extension with hexagon drive, 100 mm	1	140	140.2611	Panel lever 3 x 63 mm	1
95	159.1135	ERGOTORQUEplus screwdriver, Torx T7	1	121	150.4370	perfectLight torch 85 lumen	1	141	140.2612	Panel lever 3 x 133 mm	1
96	159.1030	ERGOTORQUEplus screwdriver, Torx, T8	1	122	911.1450	1/4" Universal joint	1	142	140.2614	Panel lever 3 x 133 mm, bent	1
97	159.1031	ERGOTORQUEplus screwdriver, Torx, T9	1	123	514.1126	2in1 quick-replacement bit holder	1				
98	159.1032	ERGOTORQUEplus screwdriver, Torx, T10	1	124	914.1410	1/4" HandReversible ratchet	1				
99	159.1033	ERGOTORQUEplus screwdriver, Torx, T15	1	125	911.3897	3/8" Reducing adaptor, 3/8" F x 1/4" M	1				
100	159.1034	ERGOTORQUEplus screwdriver, Torx, T20	1	126	911.1494	Adaptor, 1/4"Mx3/8"F	1				
101	159.1035	ERGOTORQUEplus screwdriver, Torx, T25	1								
102	159.1036	ERGOTORQUEplus screwdriver, Torx, T27	1								
103	159.1037	ERGOTORQUEplus screwdriver, Torx, T30	1								
104	159.1038	ERGOTORQUEplus screwdriver, Torx, T40	1								
105	159.1024	ERGOTORQUEplus screwdriver for screws PH3, L = 265 mm	1								
106	159.1022	ERGOTORQUEplus screwdriver for screws PH2, L = 230 mm	1								

XL 3/8" Socket spanner set

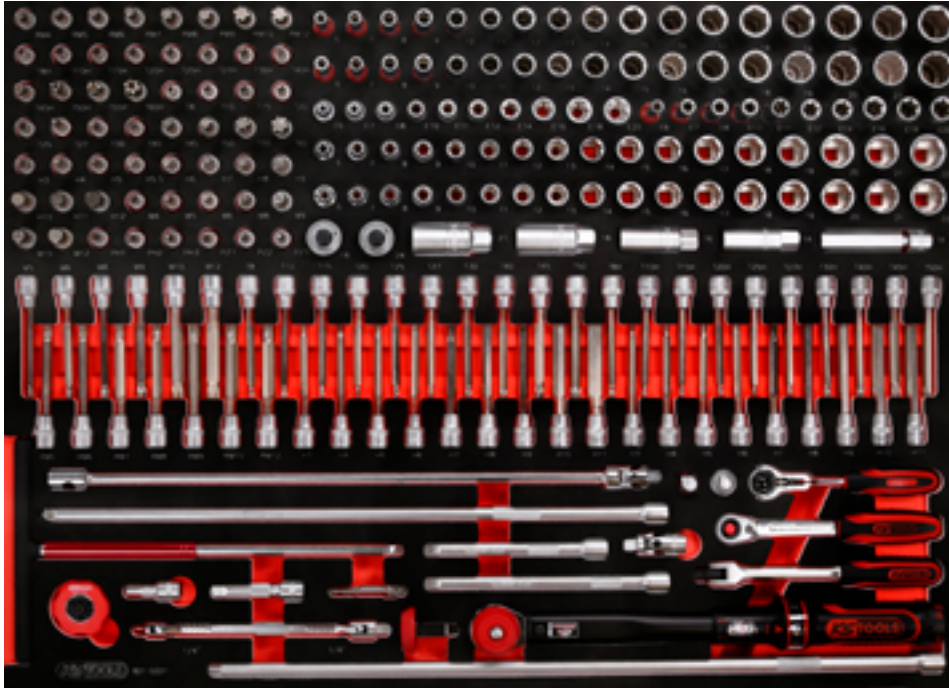

PCS
221



790 x 568



P20



P30



P45

Pos.	Code	Description	pcs	Pos.	Code	Description	pcs	Pos.	Code	Description	pcs
1	917.3921	3/8" RIBE® Bit socket, M4	1	39	911.3868	3/8" Bit socket hexagon, 8 mm	1	77	917.3856	3/8" 12 Point socket, deep, 9 mm	1
2	917.3922	3/8" RIBE® Bit socket, M5	1	40	917.3969	3/8" Bit socket hexagon, 9 mm	1	78	917.3970	3/8" 12 Point socket, deep, 10 mm	1
3	917.3923	3/8" RIBE® Bit socket, M6	1	41	917.3857	3/8" Bit socket hexagon, 10 mm	1	79	917.3971	3/8" 12 Point socket, deep, 11 mm	1
4	917.3924	3/8" RIBE® Bit socket, M7	1	42	917.3992	3/8" Bit socket hexagon, 11 mm	1	80	917.3972	3/8" 12 Point socket, deep, 12 mm	1
5	917.3925	3/8" RIBE® Bit socket, M8	1	43	911.3862	3/8" Bit socket hexagon, 12 mm	1	81	917.3973	3/8" 12 Point socket, deep, 13 mm	1
6	917.3926	3/8" RIBE® Bit socket, M9	1	44	911.3918	3/8" Bit socket spline (XZN), M4	1	82	917.3974	3/8" 12 Point socket, deep, 14 mm	1
7	917.3927	3/8" RIBE® Bit socket, M10	1	45	911.3915	3/8" Bit socket spline (XZN), M5	1	83	917.3975	3/8" 12 Point socket, deep, 15 mm	1
8	917.3928	3/8" RIBE® Bit socket, M12	1	46	911.3916	3/8" Bit socket spline (XZN), M6	1	84	917.3976	3/8" 12 Point socket, deep, 16 mm	1
9	917.3929	3/8" Bit socket Torx tamperproof, TB 8	1	47	911.3917	3/8" Bit socket spline (XZN), M8	1	85	917.3977	3/8" 12 Point socket, deep, 17 mm	1
10	911.3960	3/8" Bit socket Torx tamperproof, TB 10	1	48	917.3901	3/9" Bit socket spline (XZN), M9	1	86	917.3978	3/8" 12 Point socket, deep, 18 mm	1
11	911.3961	3/8" Bit socket Torx tamperproof, TB 15	1	49	911.3920	3/8" Bit socket spline (XZN), M10	1	87	917.3979	3/8" 12 Point socket, deep, 19 mm	1
12	911.3962	3/8" Bit socket Torx tamperproof, TB 20	1	50	917.3903	3/12" Bit socket spline (XZN), M12	1	88	917.3980	3/8" 12 Point socket, deep, 20 mm	1
13	911.3963	3/8" Bit socket Torx tamperproof, TB 25	1	51	911.3875	3/8" Bit socket, PH1	1	89	917.3981	3/8" 12 Point socket, deep, 21 mm	1
14	911.3964	3/8" Bit socket Torx tamperproof, TB 27	1	52	911.3876	3/8" Bit socket, PH2	1	90	917.3882	3/8" 12 Point socket, deep, 22 mm	1
15	911.3965	3/8" Bit socket Torx tamperproof, TB 30	1	53	911.3877	3/8" Bit socket, PH3	1	91	911.4340	3/8" Torx E Socket, E6	1
16	911.3966	3/8" Bit socket Torx tamperproof, TB 40	1	54	911.3881	3/8" Bit socket, PZ1	1	92	911.4341	3/8" Torx E Socket, E7	1
17	911.3967	3/8" Bit socket Torx tamperproof, TB 45	1	55	911.3882	3/8" Bit socket, PZ2	1	93	911.4342	3/8" Torx E Socket, E8	1
18	911.3968	3/8" Bit socket Torx tamperproof, TB 50	1	56	911.3883	3/8" Bit socket, PZ3	1	94	911.4318	3/8" Torx E Socket, E10	1
19	911.3969	3/8" Bit socket Torx tamperproof, TB 55	1	57	917.4806	3/8" Hexagonal socket, deep, 6 mm	1	95	911.4319	3/8" Torx E Socket, E11	1
20	911.3970	3/8" Bit socket Torx tamperproof, TB 60	1	58	917.4807	3/8" Hexagonal socket, deep, 7 mm	1	96	911.4320	3/8" Torx E Socket, E12	1
21	911.3934	3/8" Bit socket Torx, T8	1	59	917.3828	3/8" Hexagonal socket, deep, 8 mm	1	97	911.4321	3/8" Torx E Socket, E14	1
22	911.3887	3/8" Bit socket Torx, T10	1	60	917.3829	3/8" Hexagonal socket, deep, 9 mm	1	98	911.4343	3/8" Torx E Socket, E16	1
23	911.3869	3/8" Bit socket Torx, T15	1	61	917.3830	3/8" Hexagonal socket, deep, 10 mm	1	99	911.4344	3/8" Torx E Socket, E18	1
24	911.3870	3/8" Bit socket Torx, T20	1	62	917.3831	3/8" Hexagonal socket, deep, 11 mm	1	100	911.4345	3/8" Torx E Socket, E20	1
25	911.3871	3/8" Bit socket Torx, T25	1	63	917.3832	3/8" Hexagonal socket, deep, 12 mm	1	101	911.4386	3/8" Torx E Socket, E6, long	1
26	911.3872	3/8" Bit socket Torx, T27	1	64	917.3833	3/8" Hexagonal socket, deep, 13 mm	1	102	911.4387	3/8" Torx E Socket, E7, long	1
27	911.3873	3/8" Bit socket Torx, T30	1	65	917.3834	3/8" Hexagonal socket, deep, 14 mm	1	103	911.4388	3/8" Torx E Socket, E8, long	1
28	911.3874	3/8" Bit socket Torx, T40	1	66	917.3835	3/8" Hexagonal socket, deep, 15 mm	1	104	911.4390	3/8" Torx E Socket, E10, long	1
29	911.3885	3/8" Bit socket Torx, T45	1	67	917.3836	3/8" Hexagonal socket, deep, 16 mm	1	105	911.4391	3/8" Torx E Socket, E11, long	1
30	911.3884	3/8" Bit socket Torx, T50	1	68	917.3837	3/8" Hexagonal socket, deep, 17 mm	1	106	911.4392	3/8" Torx E Socket, E12, long	1
31	911.3888	3/8" Bit socket Torx, T55	1	69	917.3838	3/8" Hexagonal socket, deep, 18 mm	1	107	911.4394	3/8" Torx E Socket, E14, long	1
32	911.3889	3/8" Bit socket Torx, T60	1	70	917.3839	3/8" Hexagonal socket, deep, 19 mm	1	108	911.4396	3/8" Torx E Socket, E16, long	1
33	911.3863	3/8" Bit socket hexagon, 3 mm	1	71	917.3840	3/8" Hexagonal socket, deep, 20 mm	1	109	911.4398	3/8" Torx E Socket, E18, long	1
34	911.3864	3/8" Bit socket hexagon, 4 mm	1	72	917.3841	3/8" Hexagonal socket, deep, 21 mm	1	110	911.4399	3/8" Torx E Socket, E20, long	1
35	911.3865	3/8" Bit socket hexagon, 5 mm	1	73	917.3842	3/8" Hexagonal socket, deep, 22 mm	1	111	917.3806	3/8" Hexagonal socket, 6 mm	1
36	911.38655	3/8" Bit socket hexagon, 5, 5 mm	1	74	917.4831	3/8" 12 Point socket, deep, 6 mm	1	112	917.3807	3/8" Hexagonal socket, 7 mm	1
37	911.3866	3/8" Bit socket hexagon, 6 mm	1	75	917.4832	3/8" 12 Point socket, deep, 7 mm	1	113	917.3808	3/8" Hexagonal socket, 8 mm	1
38	911.3867	3/8" Bit socket hexagon, 7 mm	1	76	917.3855	3/8" 12 Point socket, deep, 8 mm	1	114	917.3809	3/8" Hexagonal socket, 9 mm	1

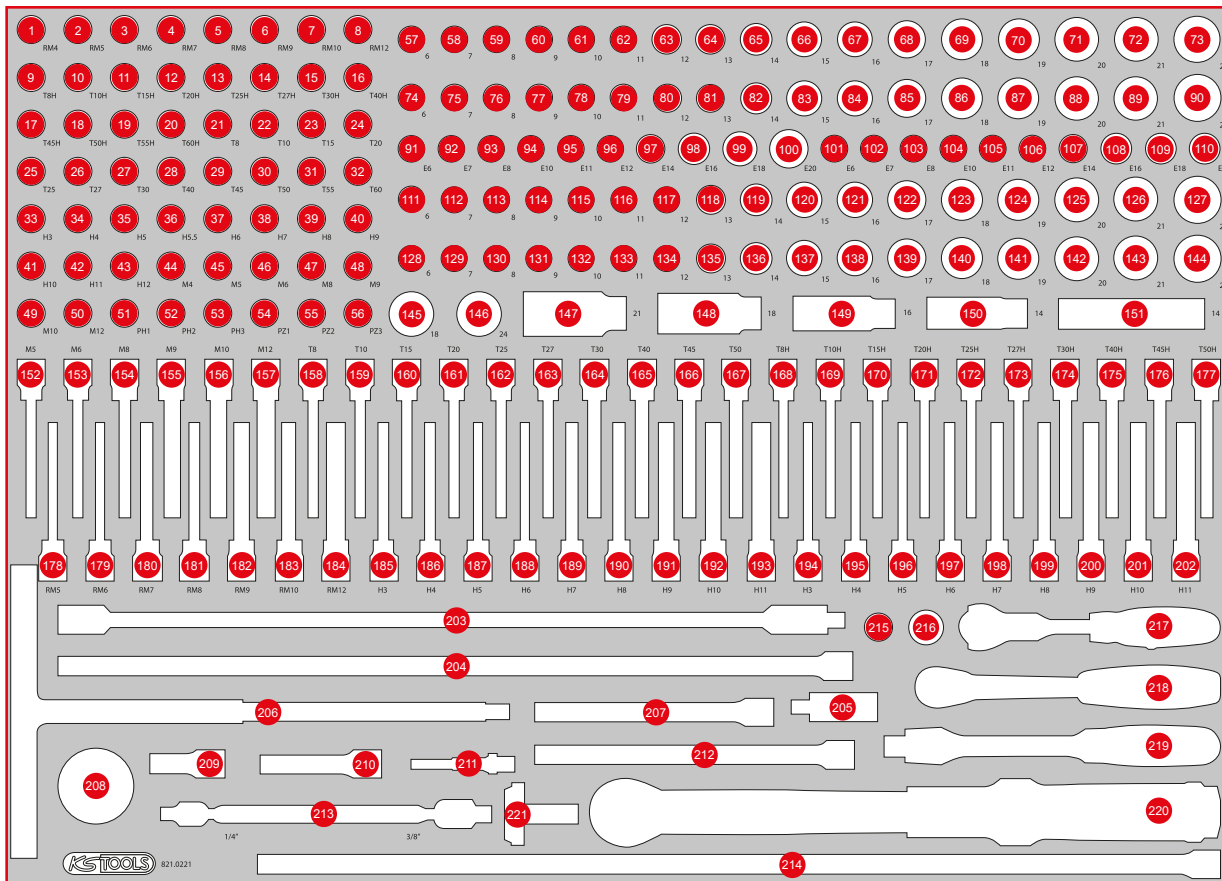

Pos.	Code	Description	pcs	Pos.	Code	Description	pcs	Pos.	Code	Description	pcs
115	917.3810	3/8" Hexagonal socket, 10 mm	1	152	917.3904	XZN spline bit socket, 3/8", M5, long	1	190	911.1565	3/8" Bit socket hexagon, long, 8 mm	1
116	917.3811	3/8" Hexagonal socket, 11 mm	1	153	917.3905	XZN spline bit socket, 3/8", M6, long	1	191	917.1594	3/8" Bit socket hexagon, long, 9 mm	1
117	917.3812	3/8" Hexagonal socket, 12 mm	1	154	917.3906	XZN spline bit socket, 3/8", M8, long	1	192	911.1566	3/8" Bit socket hexagon, long, 10 mm	1
118	917.3813	3/8" Hexagonal socket, 13 mm	1	155	917.3907	XZN spline bit socket, 3/8", M9, long	1	193	917.1595	3/8" Bit socket hexagon, long, 11 mm	1
119	917.3814	3/8" Hexagonal socket, 14 mm	1	156	917.3908	XZN spline bit socket, 3/8", M10, long	1	194	911.5393	Hex bit socket with ball end, 3/8", 3 mm	1
120	917.3815	3/8" Hexagonal socket, 15 mm	1	157	917.3909	XZN spline bit socket, 3/8", M12, long	1	195	911.5394	Hex bit socket with ball end, 3/8", 4 mm	1
121	917.3816	3/8" Hexagonal socket, 16 mm	1	158	917.1576	3/8" Bit socket Torx, long, T8	1	196	911.5395	Hex bit socket with ball end, 3/8", 5 mm	1
122	917.3817	3/8" Hexagonal socket, 17 mm	1	159	917.1577	3/8" Bit socket Torx, long, T10	1	197	911.5396	Hex bit socket with ball end, 3/8", 6 mm	1
123	917.3818	3/8" Hexagonal socket, 18 mm	1	160	917.1579	3/8" Bit socket Torx, long, T15	1	198	911.5397	Hex bit socket with ball end, 3/8", 7 mm	1
124	917.3819	3/8" Hexagonal socket, 19 mm	1	161	911.1551	3/8" Bit socket Torx, long, T20	1	199	911.5398	Hex bit socket with ball end, 3/8", 8 mm	1
125	917.3820	3/8" Hexagonal socket, 20 mm	1	162	911.1552	3/8" Bit socket Torx, long, T25	1	200	911.5399	Hex bit socket with ball end, 3/8", 9 mm	1
126	917.3821	3/8" Hexagonal socket, 21 mm	1	163	911.1553	3/8" Bit socket Torx, long, T27	1	201	911.5390	Hex bit socket with ball end, 3/8", 10 mm	1
127	917.3822	3/8" Hexagonal socket, 22 mm	1	164	911.1554	3/8" Bit socket Torx, long, T30	1	202	911.5391	Hex bit socket with ball end, 3/8", 11 mm	1
128	917.3804	3/8" 12 Point socket, 6 mm	1	165	911.1555	3/8" Bit socket Torx, long, T40	1	203	517.1126	T-Handle universal wrench for sockets, extra long, 3/8"	1
129	917.3805	3/8" 12 Point socket, 7 mm	1	166	911.1556	3/8" Bit socket Torx, long, T45	1	204	911.4884	3/8" Extensions 500 mm	1
130	911.3981	3/8" 12 Point socket, 8 mm	1	167	911.1557	3/8" Bit socket Torx, long, T50	1	205	911.3850	3/8" Universal joint	1
131	911.3982	3/8" 12 Point socket, 9 mm	1	168	917.3938	3/8" Bit socket Torx tamperproof, long, TB 8	1	206	911.3931	3/8" T-Handle-Spinner	1
132	911.3983	3/8" 12 Point socket, 10 mm	1	169	917.3937	3/8" Bit socket Torx tamperproof, long, TB 10	1	207	911.3802	3/8" Extensions 150 mm	1
133	911.3984	3/8" 12 Point socket, 11 mm	1	170	911.3939	3/8" Bit socket Torx tamperproof, long, TB 15	1	208	914.3810	3/8" HandReversible ratchet	1
134	911.3985	3/8" 12 Point socket, 12 mm	1	171	911.3971	3/8" Bit socket Torx tamperproof, long, TB 20	1	209	911.3852	3/8" Extensions 45 mm	1
135	911.3986	3/8" 12 Point socket, 13 mm	1	172	911.3972	3/8" Bit socket Torx tamperproof, long, TB 25	1	210	911.3801	3/8" Extensions 75 mm	1
136	911.3987	3/8" 12 Point socket, 14 mm	1	173	911.3973	3/8" Bit socket Torx tamperproof, long, TB 27	1	211	514.1107	Socket adaptor, 1/4"x3/8"	1
137	911.3988	3/8" 12 Point socket, 15 mm	1	174	911.3974	3/8" Bit socket Torx tamperproof, long, TB 30	1	212	911.3856	3/8" Extensions 200 mm	1
138	911.3989	3/8" 12 Point socket, 16 mm	1	175	911.3975	3/8" Bit socket Torx tamperproof, long, TB 40	1	213	517.0338	Double-joint-spanner for 1/4" and 3/8" sockets	1
139	911.3992	3/8" 12 Point socket, 17 mm	1	176	911.3976	3/8" Bit socket Torx tamperproof, long, TB 45	1	214	911.4892	3/8" Extensions 600 mm	1
140	911.3993	3/8" 12 Point socket, 18 mm	1	177	911.3977	3/8" Bit socket Torx tamperproof, long, TB 50	1	215	911.3892	Adaptor, 3/8" Fx1/2" M	1
141	911.3994	3/8" 12 Point socket, 19 mm	1	178	917.3930	3/8" RIBE® Bit socket, long, M5	1	216	911.1233	Reducing adaptor, 1/2" F x 3/8" M	1
142	917.4811	3/8" 12 Point socket, 20 mm	1	179	917.3931	3/8" RIBE® Bit socket, long, M6	1	217	914.3815	3/8" MODIFIX mini T-handle swivel head ratchet, 72 teeth, 0° +90°	1
143	911.3996	3/8" 12 Point socket, 21 mm	1	180	917.3932	3/8" RIBE® Bit socket, long, M7	1	218	920.3890	3/8" SlimPOWER Reversible ratchet, 72 teeth	1
144	911.3997	3/8" 12 Point socket, 22 mm	1	181	917.3933	3/8" RIBE® Bit socket, long, M8	1	219	917.3939	3/8" Flexi head drive handle	1
145	516.1501	Torque limiter for spark plugs, 3/8", 18Nm	1	182	917.3934	3/8" RIBE® Bit socket, long, M9	1	220	516.1432	1/2" ERGOTORQUE® precision torque wrench with rotary mushroom ratchet head, 20-100Nm	1
146	516.1502	Torque limiter for spark plugs, 3/8", 24Nm	1	183	917.3935	3/8" RIBE® Bit socket, long, M10	1	221	516.1428	Rotary square box wrench, 1/2"x3/8"	1
147	911.3805	3/8" Spark plug socket, 21 mm	1	184	917.3936	3/8" RIBE® Bit socket, long, M12	1				
148	911.3823	3/8" Spark plug socket, 18 mm	1	185	917.1593	3/8" Bit socket hexagon, long, 3 mm	1				
149	911.3804	3/8" Spark plug socket, 16 mm	1	186	911.1561	3/8" Bit socket hexagon, long, 4 mm	1				
150	911.3990	3/8" Spark plug socket, 14 mm	1	187	911.1562	3/8" Bit socket hexagon, long, 5 mm	1				
151	911.3999	3/8" Special spark plug socket for BMW with flexible joint, 14 mm	1	188	911.1563	3/8" Bit socket hexagon, long, 6 mm	1				
				189	911.1564	3/8" Bit socket hexagon, long, 7 mm	1				

XL 1/2" Socket spanner set



Pos.	Code	Description	pcs	Pos.	Code	Description	pcs	Pos.	Code	Description	pcs
1	911.1304	1/2" Bit socket hexagon, short, 4 mm	1	28	911.1343	1/2" Bit socket spline (XZN), M10, 55 mm	1	54	917.1316	1/2" Bit socket hexagon, short, 3/16"	1
2	911.1305	1/2" Bit socket hexagon, short, 5 mm	1	29	911.1344	1/2" Bit socket spline (XZN), M12, 55 mm	1	55	917.1318	1/2" Bit socket hexagon, short, 1/4"	1
3	911.13055	1/2" Bit socket hexagon, short, 5,5 mm	1	30	911.1345	1/2" Bit socket spline (XZN), M14, 55 mm	1	56	917.1319	1/2" Bit socket hexagon, short, 9/32"	1
4	911.1306	1/2" Bit socket hexagon, short, 6 mm	1	31	911.1346	1/2" Bit socket spline (XZN), M16, 55 mm	1	57	917.1320	1/2" Bit socket hexagon, short, 5/16"	1
5	911.1307	1/2" Bit socket hexagon, short, 7 mm	1	32	911.5306	1/2" Bit socket spline (XZN), M17, 55 mm	1	58	911.5386	1/2" Bit socket hexagon, short, 11/32"	1
6	911.1308	1/2" Bit socket hexagon, short, 8 mm	1	33	911.1348	1/2" Bit socket spline (XZN) tamperproof, M16, 55 mm	1	59	917.1321	1/2" Bit socket hexagon, short, 3/8"	1
7	911.1309	1/2" Bit socket hexagon, short, 9 mm	1	34	911.1361	1/2" Bit socket Torx, T20	1	60	911.5387	1/2" Bit socket hexagon, short, 7/16"	1
8	911.1310	1/2" Bit socket hexagon, short, 10 mm	1	35	911.1362	1/2" Bit socket Torx, T25	1	61	917.1322	1/2" Bit socket hexagon, short, 1/2"	1
9	911.1312	1/2" Bit socket hexagon, short, 12 mm	1	36	911.1363	1/2" Bit socket Torx, T27	1	62	917.1323	1/2" Bit socket hexagon, short, 9/16"	1
10	911.1314	1/2" Bit socket hexagon, short, 14 mm	1	37	911.1364	1/2" Bit socket Torx, T30	1	63	917.1324	1/2" Bit socket hexagon, short, 5/8"	1
11	911.1317	1/2" Bit socket hexagon, short, 17 mm	1	38	911.1365	1/2" Bit socket Torx, T40	1	64	911.1581	1/2" 12 Point socket, 21 mm	1
12	911.1319	1/2" Bit socket hexagon, short, 19 mm	1	39	911.1366	1/2" Bit socket Torx, T45	1	65	911.1582	1/2" 12 Point socket, 22 mm	1
13	911.4511	Bit socket for RIBE screws, M5, length 55 mm	1	40	911.1367	1/2" Bit socket Torx, T50	1	66	911.1583	1/2" 12 Point socket, 23 mm	1
14	911.4512	Bit socket for RIBE screws, M6, length 55 mm	1	41	911.1368	1/2" Bit socket Torx, T55	1	67	911.1584	1/2" 12 Point socket, 24 mm	1
15	911.4513	Bit socket for RIBE screws, M7, length 55 mm	1	42	911.1369	1/2" Bit socket Torx, T60	1	68	917.1364	1/2" 12 Point socket, 26 mm	1
16	911.4514	Bit socket for RIBE screws, M8, length 55 mm	1	43	911.1370	1/2" Bit socket Torx, T70	1	69	911.1585	1/2" 12 Point socket, 27 mm	1
17	911.4515	Bit socket for RIBE screws, M9, length 55 mm	1	44	911.1371	1/2" Bit socket Torx tamperproof, TB20	1	70	917.1365	1/2" 12 Point socket, 28 mm	1
18	911.4516	Bit socket for RIBE screws, M10, length 55 mm	1	45	911.1372	1/2" Bit socket Torx tamperproof, TB25	1	71	911.1586	1/2" 12 Point socket, 30 mm	1
19	911.4551	Bit socket for RIBE screws, M10.1, length 55 mm	1	46	911.1373	1/2" Bit socket Torx tamperproof, TB27	1	72	911.1587	1/2" 12 Point socket, 32 mm	1
20	911.4517	Bit socket for RIBE screws, M12, length 55 mm	1	47	911.1374	1/2" Bit socket Torx tamperproof, TB30	1	73	911.1570	1/2" 12 Point socket, 10 mm	1
21	911.4518	Bit socket for RIBE screws, M13, length 55 mm	1	48	911.1375	1/2" Bit socket Torx tamperproof, TB40	1	74	911.1571	1/2" 12 Point socket, 11 mm	1
22	911.4519	Bit socket for RIBE screws, M14, length 55 mm	1	49	911.1376	1/2" Bit socket Torx tamperproof, TB45	1	75	911.1572	1/2" 12 Point socket, 12 mm	1
23	911.4552	Bit socket for RIBE screws, M16, length 55 mm	1	50	911.1377	1/2" Bit socket Torx tamperproof, TB50	1	76	911.1573	1/2" 12 Point socket, 13 mm	1
24	911.1340	1/2" Bit socket spline (XZN), M5, 55 mm	1	51	911.1378	1/2" Bit socket Torx tamperproof, TB55	1	77	911.1574	1/2" 12 Point socket, 14 mm	1
25	911.1341	1/2" Bit socket spline (XZN), M6, 55 mm	1	52	911.1379	1/2" Bit socket Torx tamperproof, TB60	1	78	911.1575	1/2" 12 Point socket, 15 mm	1
26	911.1342	1/2" Bit socket spline (XZN), M8, 55 mm	1	53	911.1380	1/2" Bit socket Torx tamperproof, TB70	1	79	911.1576	1/2" 12 Point socket, 16 mm	1
27	911.1313	1/2" Bit socket spline (XZN), M9, 55 mm	1					80	911.1577	1/2" 12 Point socket, 17 mm	1

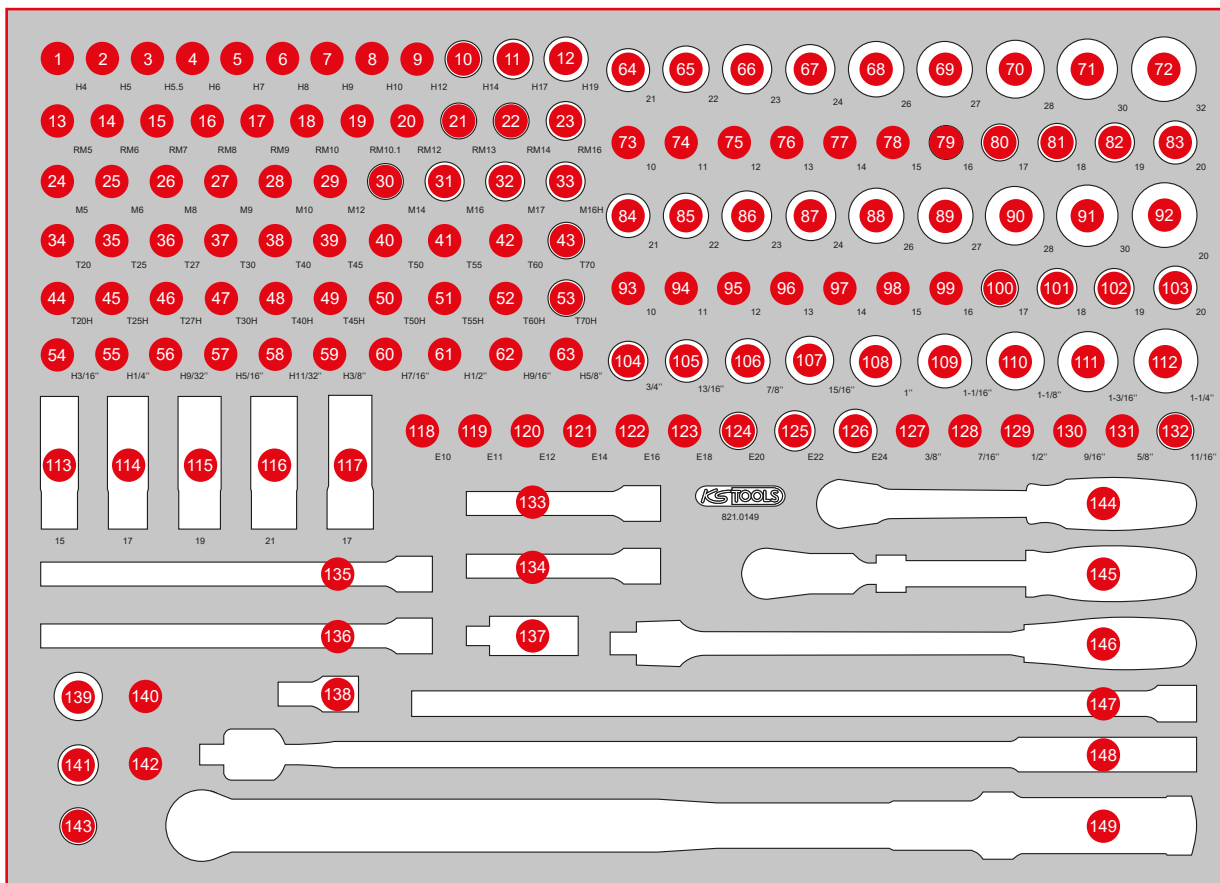

Pos.	Code	Description	pcs	Pos.	Code	Description	pcs	Pos.	Code	Description	pcs
81	911.1578	1/2" 12 Point socket, 18 mm	1	108	917.1383	1/2" 12 Point socket, 1"	1	134	911.1383	Wobble extension, 1/2", 125 mm	1
82	911.1579	1/2" 12 Point socket, 19 mm	1	109	917.1384	1/2" 12 Point socket, 1.1/16"	1	135	911.1203	1/2" Extensions, 250 mm	1
83	911.1580	1/2" 12 Point socket, 20 mm	1	110	917.1385	1/2" 12 Point socket, 1.1/8"	1	136	911.1384	Wobble extension, 1/2", 250 mm	1
84	917.1221	1/2" Hexagonal socket, 21 mm	1	111	917.1386	1/2" 12 Point socket, 1.3/16"	1	137	911.1250	1/2" Universal joint	1
85	917.1222	1/2" Hexagonal socket, 22 mm	1	112	917.1387	1/2" 12 Point socket, 1.1/4"	1	138	911.1381	Wobble extension, 1/2", 50 mm	1
86	917.1223	1/2" Hexagonal socket, 23 mm	1	113	515.0991	SlimPOWER 1/2" Alloy rim impact socket, 15 mm	1	139	911.3412	Reducing adaptor 3/4" F x 1/2" M	1
87	917.1224	1/2" Hexagonal socket, 24 mm	1	114	515.0992	SlimPOWER 1/2" Alloy rim impact socket, 17 mm	1	140	911.1233	Reducing adaptor, 1/2" F x 3/8" M	1
88	917.1343	1/2" Hexagonal socket, 26 mm	1	115	515.0993	SlimPOWER 1/2" Alloy rim impact socket, 19 mm	1	141	911.1234	Adaptor, 1/2" F x 3/4" M	1
89	917.1227	1/2" Hexagonal socket, 27 mm	1	116	515.0994	SlimPOWER 1/2" Alloy rim impact socket, 21 mm	1	142	911.3892	Adaptor, 3/8" F x 1/2" M	1
90	917.1344	1/2" Hexagonal socket, 28 mm	1	117	515.2055	Special aluminium rims special profile impact socket for Mercedes, long, 17 mm	1	143	911.1207	3/8" Sliding adaptor, 3/8" F x 1/2" M	1
91	917.1230	1/2" Hexagonal socket, 30 mm	1	118	911.4333	1/2" Torx E Socket, E10	1	144	920.1290	1/2" SlimPOWER Reversible ratchet, 72 teeth	1
92	917.1232	1/2" Hexagonal socket, 32 mm	1	119	911.4334	1/2" Torx E Socket, E11	1	145	914.1220	1/2" SlimPOWER Telescopic reversible ratchet, 72 teeth	1
93	917.1210	1/2" Hexagonal socket, 10 mm	1	120	911.4335	1/2" Torx E Socket, E12	1	146	917.1455	1/2" Flexi head drive handle	1
94	917.1211	1/2" Hexagonal socket, 11 mm	1	121	911.4336	1/2" Torx E Socket, E14	1	147	911.1836	Wobble extension, 1/2", 500 mm	1
95	917.1212	1/2" Hexagonal socket, 12 mm	1	122	911.4322	1/2" Torx E Socket, E16	1	148	918.1292	1/2" CHROMEplus Flexi head drive handle, 600 mm	1
96	917.1213	1/2" Hexagonal socket, 13 mm	1	123	911.4323	1/2" Torx E Socket, E18	1	149	516.1482	1/2" ERGOTORQUE® precision torque wrench with rotary mushroom ratchet head, 80-420Nm	1
97	917.1214	1/2" Hexagonal socket, 14 mm	1	124	911.4324	1/2" Torx E Socket, E20	1				
98	917.1215	1/2" Hexagonal socket, 15 mm	1	125	911.4325	1/2" Torx E Socket, E22	1				
99	917.1216	1/2" Hexagonal socket, 16 mm	1	126	911.4326	1/2" Torx E Socket, E24	1				
100	917.1217	1/2" Hexagonal socket, 17 mm	1	127	917.1370	1/2" 12 Point socket, 3/8"	1				
101	917.1218	1/2" Hexagonal socket, 18 mm	1	128	917.1372	1/2" 12 Point socket, 7/16"	1				
102	917.1219	1/2" Hexagonal socket, 19 mm	1	129	917.1373	1/2" 12 Point socket, 1/2"	1				
103	917.1220	1/2" Hexagonal socket, 20 mm	1	130	917.1374	1/2" 12 Point socket, 9/16"	1				
104	917.1378	1/2" 12 Point socket, 3/4"	1	131	917.1376	1/2" 12 Point socket, 5/8"	1				
105	917.1380	1/2" 12 Point socket, 13/16"	1	132	917.1377	1/2" 12 Point socket, 11/16"	1				
106	917.1381	1/2" 12 Point socket, 7/8"	1	133	911.1202	1/2" Extensions, 125 mm	1				
107	917.1382	1/2" 12 Point socket, 15/16"	1								

821.0076

XL Screw spanner set



Pos.	Code	Description	pcs	Pos.	Code	Description	pcs	Pos.	Code	Description	pcs
1	517.0813	Double ring spanner, offset, 20 x 22 mm	1	16	503.4618	GEARplus reversing combination ratcheting spanner, 18 mm	1	26	503.4608	GEARplus reversing combination ratcheting spanner, 8 mm	1
2	517.0812	Double ring spanner, offset, 18 x 19 mm	1	17	503.4617	GEARplus reversing combination ratcheting spanner, 17 mm	1	27	503.4290	GEARplus bit adaptor, 1/4" x 10 mm	1
3	517.0810	Double ring spanner, offset, 16 x 17 mm	1	18	503.4616	GEARplus reversing combination ratcheting spanner, 16 mm	1	28	503.4296	GEARplus socket adaptor, 1/4" x 10 mm	1
4	517.0809	Double ring spanner, offset, 14 x 15 mm	1	19	503.4615	GEARplus reversing combination ratcheting spanner, 15 mm	1	29	503.4297	GEARplus socket adaptor, 3/8" x 13 mm	1
5	517.0807	Double ring spanner, offset, 12 x 13 mm	1	20	503.4614	GEARplus reversing combination ratcheting spanner, 14 mm	1	30	503.4298	GEARplus socket adaptor, 1/2" x 19 mm	1
6	517.0804	Double ring spanner, offset, 10 x 11 mm	1	21	503.4613	GEARplus reversing combination ratcheting spanner, 13 mm	1	31	518.0017	CHROMEplus Combination spanner, stubby, 17 mm	1
7	517.0802	Double ring spanner, offset, 8 x 9 mm	1	22	503.4612	GEARplus reversing combination ratcheting spanner, 12 mm	1	32	518.0016	CHROMEplus Combination spanner, stubby, 16 mm	1
8	517.0801	Double ring spanner, offset, 6 x 7 mm	1	23	503.4611	GEARplus reversing combination ratcheting spanner, 11 mm	1	33	518.0015	CHROMEplus Combination spanner, stubby, 15 mm	1
9	518.0528	Open double ring spanner, with double joint, 10 x 11	1	24	503.4610	GEARplus reversing combination ratcheting spanner, 10 mm	1	34	518.0014	CHROMEplus Combination spanner, stubby, 14 mm	1
10	517.0252	Open double ring spanner, offset, 8 x 10 mm	1	25	503.4609	GEARplus reversing combination ratcheting spanner, 9 mm	1	35	518.0013	CHROMEplus Combination spanner, stubby, 13 mm	1
11	517.9244	Open double ring spanner, offset, 11 x 13 mm	1					36	518.0012	CHROMEplus Combination spanner, stubby, 12 mm	1
12	517.0258	Open double ring spanner, offset, 12 x 14 mm	1								
13	517.0263	Open double ring spanner, offset, 16 x 18 mm	1								
14	517.0264	Open double ring spanner, offset, 17 x 19 mm	1								
15	503.4619	GEARplus reversing combination ratcheting spanner, 19 mm	1								

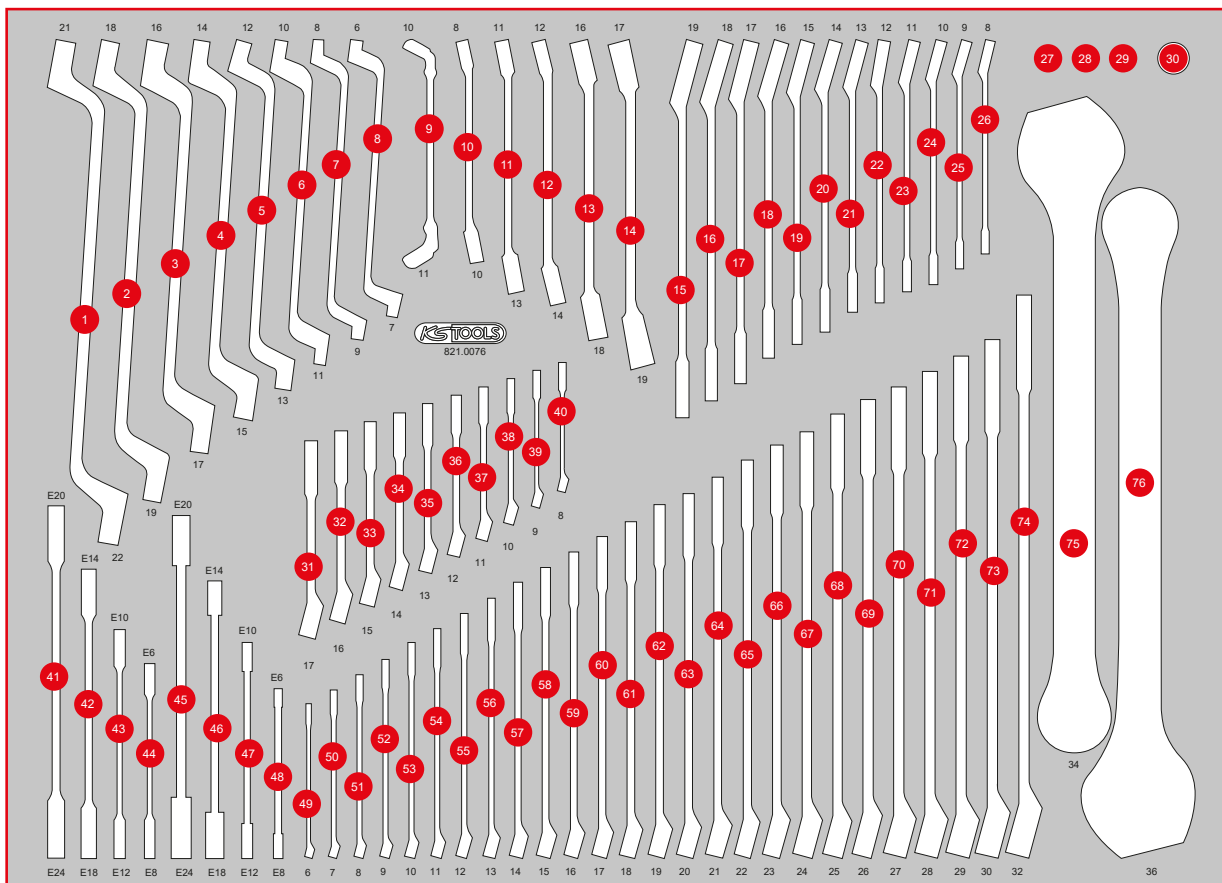

Pos.	Code	Description	pcs	Pos.	Code	Description	pcs	Pos.	Code	Description	pcs
37	518.0011	CHROMEplus Combination spanner, stubby, 11 mm	1	49	517.0606	Combination spanners, offset, 6 mm	1	66	517.0623	Combination spanners, offset, 23 mm	1
38	518.0010	CHROMEplus Combination spanner, stubby, 10 mm	1	50	517.0607	Combination spanners, offset, 7 mm	1	67	517.0624	Combination spanners, offset, 24 mm	1
39	518.0008	CHROMEplus Combination spanner, stubby, 9 mm	1	51	517.0608	Combination spanners, offset, 8 mm	1	68	517.0625	Combination spanners, offset, 25 mm	1
40	518.0007	CHROMEplus Combination spanner, stubby, 8 mm	1	52	517.0609	Combination spanners, offset, 9 mm	1	69	517.0626	Combination spanners, offset, 26 mm	1
41	503.4357	GEARplus Double ring ratchet spanner, E20 x E24	1	53	517.0610	Combination spanners, offset, 10 mm	1	70	517.0627	Combination spanners, offset, 27 mm	1
42	503.4355	GEARplus Double ring ratchet spanner, E14 x E18	1	54	517.0611	Combination spanners, offset, 11 mm	1	71	517.0628	Combination spanners, offset, 28 mm	1
43	503.4353	GEARplus Double ring ratchet spanner, E10 x E12	1	55	517.0612	Combination spanners, offset, 12 mm	1	72	517.0629	Combination spanners, offset, 29 mm	1
44	503.4351	GEARplus Double ring ratchet spanner, E6 x E8	1	56	517.0613	Combination spanners, offset, 13 mm	1	73	517.0630	Combination spanners, offset, 30 mm	1
45	911.0376	Double ring spanner for Torx E profile, E20 x E24	1	57	517.0614	Combination spanners, offset, 14 mm	1	74	517.0632	Combination spanners, offset, 32 mm	1
46	911.0374	Double ring spanner for Torx E profile, E14 x E18	1	58	517.0615	Combination spanners, offset, 15 mm	1	75	517.0634	Combination spanners, offset, 34 mm	1
47	911.0373	Double ring spanner for Torx E profile, E10 x E12	1	59	517.0616	Combination spanners, offset, 16 mm	1	76	517.0636	Combination spanners, offset, 36 mm	1
48	911.0371	Double ring spanner for Torx E profile, E6 x E8	1	60	517.0617	Combination spanners, offset, 17 mm	1				
				61	517.0618	Combination spanners, offset, 18 mm	1				
				62	517.0619	Combination spanners, offset, 19 mm	1				
				63	517.0620	Combination spanners, offset, 20 mm	1				
				64	517.0621	Combination spanners, offset, 21 mm	1				
				65	517.0622	Combination spanners, offset, 22 mm	1				

811.1018

M T-handle key wrench set

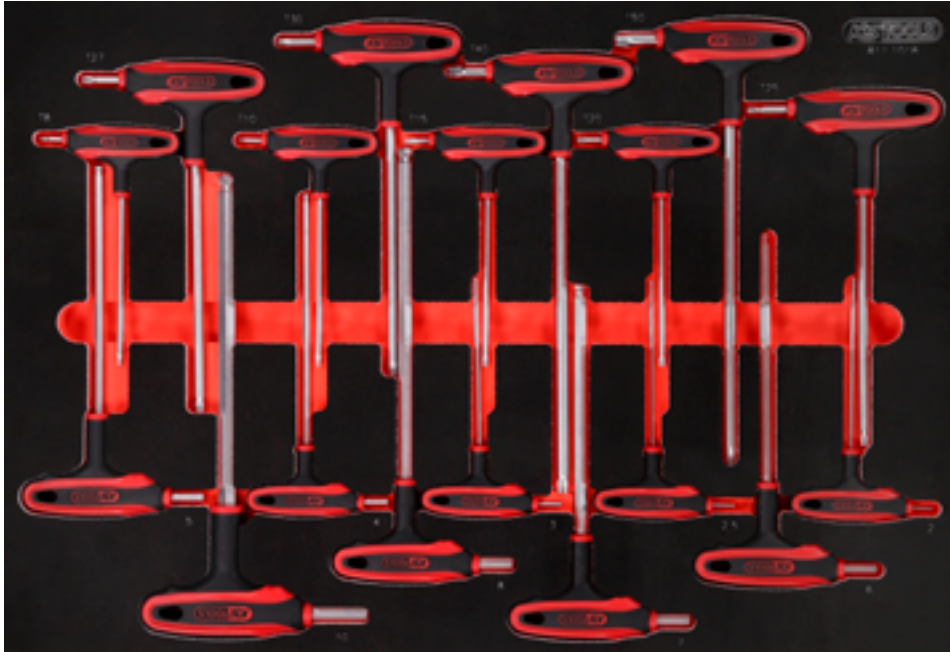

Pos.	Code	Description	pcs
1	151.2753	T-handle Torx key wrench, ball end, T8	1
2	151.2759	T-handle Torx key wrench, ball end, T27	1
3	151.2755	T-handle Torx key wrench, ball end, T10	1
4	151.2760	T-handle Torx key wrench, ball end, T30	1
5	151.2756	T-handle Torx key wrench, ball end, T15	1
6	151.2761	T-handle Torx key wrench, ball end, T40	1
7	151.2757	T-handle Torx key wrench, ball end, T20	1
8	151.2853	T-handle Torx key wrench, ball end, T50	1
9	151.2758	T-handle Torx key wrench, ball end, T25	1
10	151.8134	T-handle ball ended hexagon key wrench, 5 mm	1
11	151.8138	T-handle ball ended hexagon key wrench, 10 mm	1
12	151.8133	T-handle ball ended hexagon key wrench, 4 mm	1
13	151.8137	T-handle ball ended hexagon key wrench, 8 mm	1
14	151.8132	T-handle ball ended hexagon key wrench, 3 mm	1
15	151.8136	T-handle ball ended hexagon key wrench, 7 mm	1
16	151.8131	T-handle ball ended hexagon key wrench, 2,5 mm	1
17	151.8135	T-handle ball ended hexagon key wrench, 6 mm	1
18	151.8130	T-handle ball ended hexagon key wrench, 2 mm	1

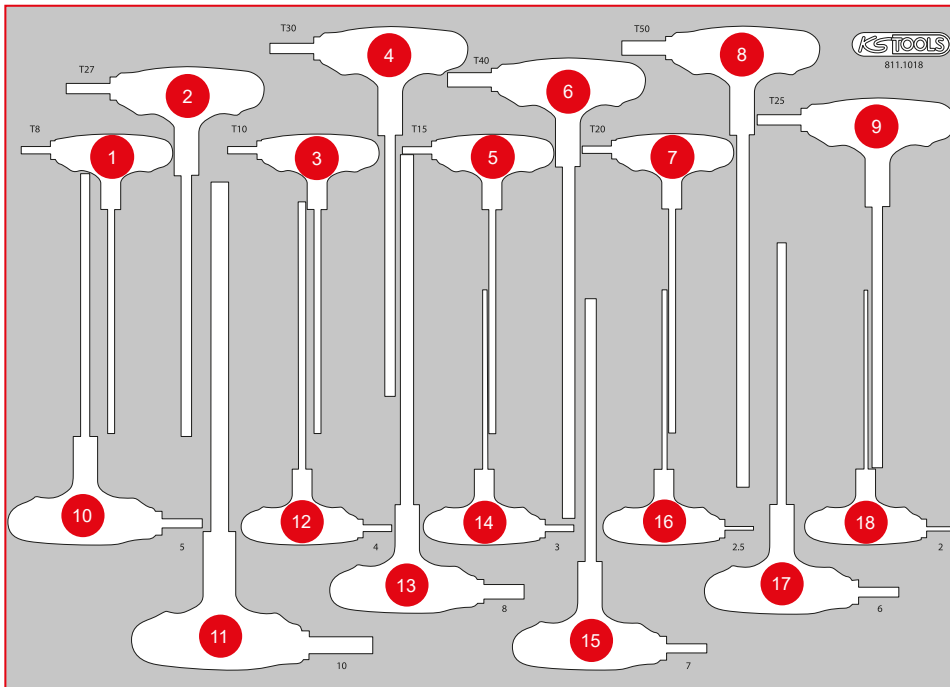

811.2018

M T-handle key wrench set



568 x 398

P10

P10TC

P15

P20

P30

P35

P45



Pos.	Code	Description	pcs
1	158.5006	T-handle socket screwdriver, long, 6 mm	1
2	158.5010	T-handle socket screwdriver, long, 10 mm	1
3	158.5007	T-handle socket screwdriver, long, 7 mm	1
4	158.5012	T-handle socket screwdriver, long, 12 mm	1
5	158.5008	T-handle socket screwdriver, long, 8 mm	1
6	158.5013	T-handle socket screwdriver, long, 13 mm	1
7	158.5009	T-handle socket screwdriver, long, 9 mm	1
8	159.1126	ERGOTORQUEplus Socket screwdriver, 6 mm	1
9	159.1204	ERGOTORQUEplus Socket screwdriver, 6 mm	1
10	159.1205	ERGOTORQUEplus Socket screwdriver, 7 mm	1
11	159.1206	ERGOTORQUEplus Socket screwdriver, 8 mm	1
12	159.1207	ERGOTORQUEplus Socket screwdriver, 9 mm	1
13	159.1208	ERGOTORQUEplus Socket screwdriver, 10 mm	1
14	159.1209	ERGOTORQUEplus Socket screwdriver, 11 mm	1
15	159.1210	ERGOTORQUEplus Socket screwdriver, 12 mm	1
16	159.1211	ERGOTORQUEplus Socket screwdriver, 13 mm	1
17	159.1127	ERGOTORQUEplus Socket screwdriver, 7 mm	1
18	911.1128	ERGOTORQUE Socket screwdriver, 8 mm	1

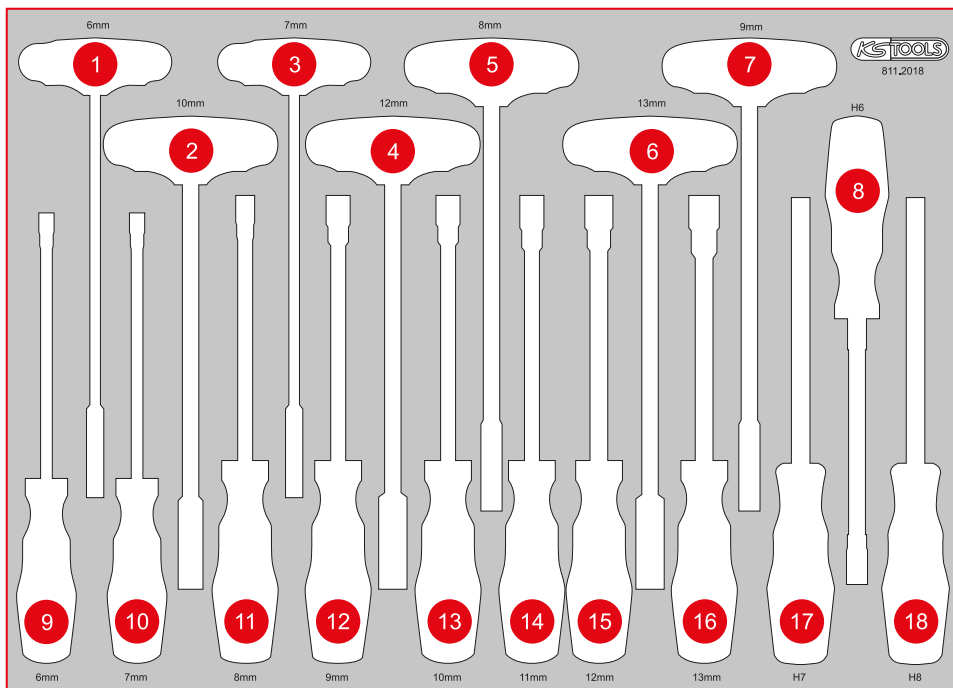

821.0034

XL Spanner set

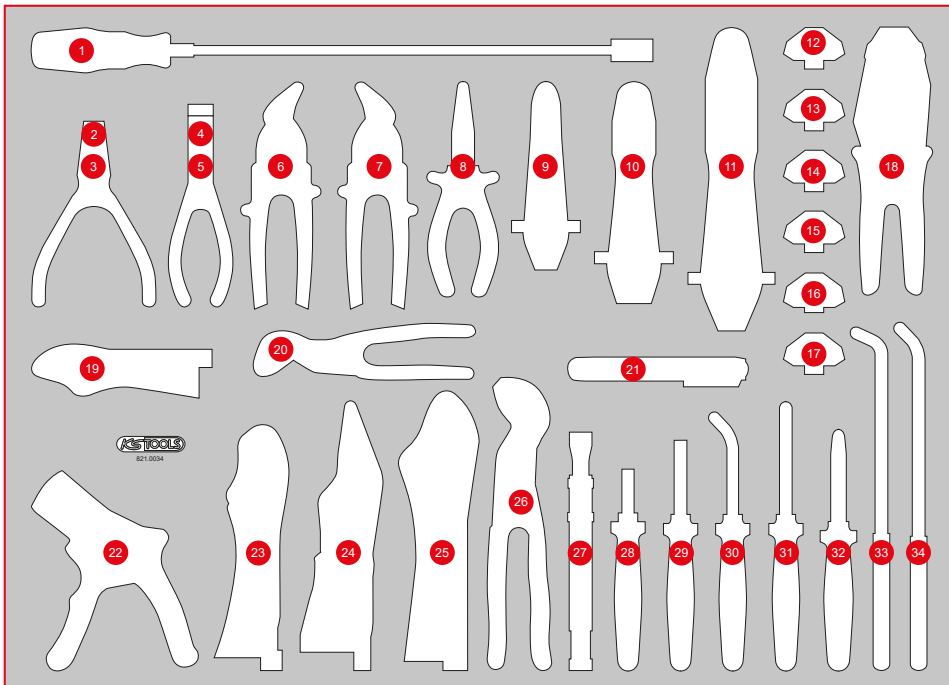

Pos.	Code	Description	pcs
1	550.1025	Flexible magnet lifter, 510 mm, Øhead=15 mm	1
2	500.1026	Circlip pliers for external circlips, angled, 160 mm	1
3	500.1029	Circlip pliers for external circlips, 160 mm	1
4	500.1032	Circlip pliers for internal circlips, angled, 160 mm	1
5	500.1035	Circlip pliers for internal circlips, 160 mm	1
6	118.0151	Mini metal shears, right handed cut	1
7	118.0153	Mini metal shears, left handed cut	1
8	115.1016	ERGOTORQUE flat pliers serrated, 160 mm	1
9	115.5052	Hose clamp gripper, Ø 15 mm	1
10	115.5053	Hose clamp gripper, Ø 30 mm	1
11	115.5054	Hose clamp gripper, Ø 60 mm	1
12	115.1415	Pair of crimp inserts for insulated cable lugs, Ø 0.5 - 6 mm	1
13	115.1416	Pair of crimp inserts for uninsulated cable lugs, Ø 0.5 - 10 mm	1
14	115.1417	Pair of crimp inserts for flat plugs 4.8 und 6.3 mm, Ø 0.5 - 6.0 mm	1
15	115.1418	Pair of crimp inserts for wire end ferrules, Ø 0.5 - 4 mm	1
16	115.1420	Crimp head for pin terminals	1
17	115.1421	Crimp head for non-insulated terminals	1
18	115.1401	Crimping tool	1
19	115.1031	Locking pliers, 50 mm, 140 mm	1
20	115.2011	Water pump pliers, 175 mm	1
21	150.2199	Brake fluid tester	1
22	115.1239	Self regulating wire stripper, 0,2-6 mm	1
23	115.1175	Round jaw-American type, 175 mm	1
24	115.2034	Long-nose locking pliers with quick-release lever, 45 mm, L=170 mm	1
25	115.1033	Self grip wrench, 220 mm	1
26	115.2010	Water pump pliers, 240 mm	1
27	115.1084	Welding self grip pliers, 195 mm	1
28	115.1012	ERGOTORQUE diagonal side cutter, 160 mm	1
29	115.1021	ERGOTORQUE combination pliers, 180 mm	1
30	115.1019	ERGOTORQUE bent nose pliers serrated, 210 mm	1
31	115.1024	ERGOTORQUE long nose pliers serrated cutter, 200 mm	1
32	115.1013	ERGOTORQUE power side cutter, 180 mm	1
33	500.7048	Sparkplug plier 12 mm	1
34	500.7052	Telephone pliers 45° curved, extra long, 270 mm	1

811.0020

M Hammer and chisel set



568 x 398



P10



P10TC



P15



P20



P30



P35



P45



Pos.	Code	Description	pcs
1	156.0236	Pin punch, Ø 2 mm, cylindrical shaft	1
2	156.0231	Pin punch, Ø 3 mm, cylindrical shaft	1
3	156.0232	Pin punch, Ø 4 mm, cylindrical shaft	1
4	156.0233	Pin punch, Ø 5 mm, cylindrical shaft	1
5	156.0234	Pin punch, Ø 6 mm, cylindrical shaft	1
6	156.0235	Pin punch, Ø 8 mm, cylindrical shaft	1
7	156.0237	Punch, Ø 3 mm, conical	1
8	156.0238	Punch, Ø 4 mm, conical	1
9	156.0244	Punch, Ø 5 mm, conical	1
10	156.0242	Cross chisel, octagon, 7 mm	1
11	156.0251	Flat chisel, octagon, 10 mm	1
12	156.0252	Flat chisel, octagon, 12 mm	1
13	156.0253	Flat chisel, octagon, 16 mm	1
14	156.0254	Flat chisel, octagon, 18 mm	1
15	156.0241	Flat chisel, octagon, 20 mm	1
16	140.5252	Recoil free soft faced Hammer, 400 g	1
17	142.1402	Fitters Hammer, fibreglas handle, 400 g	1
18	142.1321	Fitters Hammer, fibreglas handle, 200 g	1
19	140.5271	Recoil free soft faced Hammer, 480 g	1
20	142.5101	Club Hammer, fibreglas handle, 1000 g	1

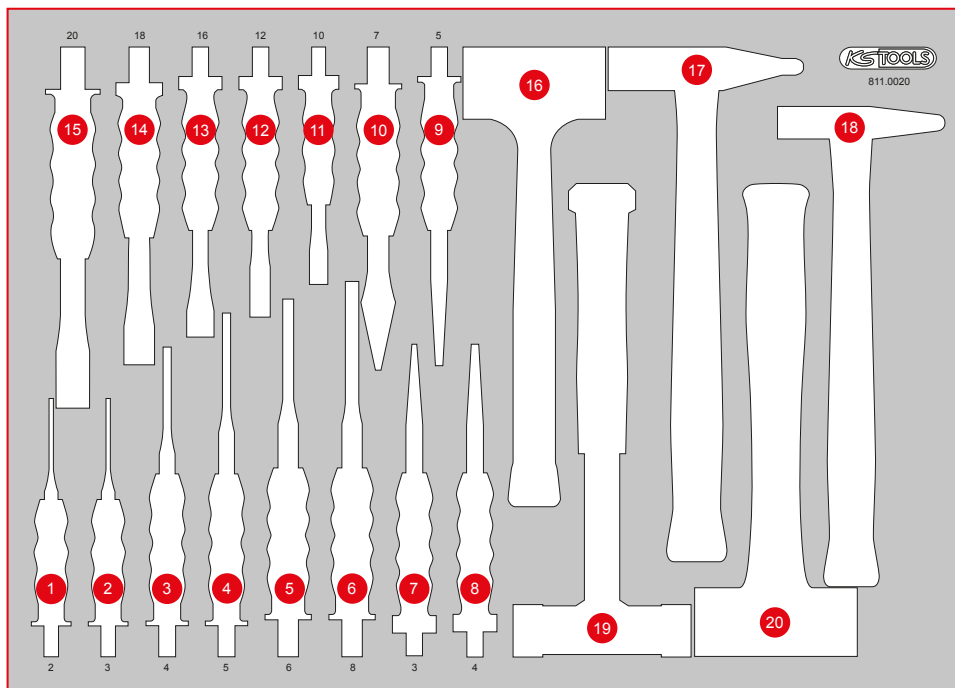

M Measuring tool and file set



Pos.	Code	Description	pcs
1	300.0104	Flexible steel rule, 300 mm	1
2	300.0700	Protractor with rule, 220 mm	1
3	156.0466	Automatic centre punch, Ø 4 mm	1
4	300.0510	Pocket vernier calliper 0 - 150 mm, 235 mm	1
5	300.0600	Feeler gauge, 20 Blades, 0,05 - 1 mm	1
6	201.2335	Steel wire brake saddle brush, 2-row, straight 225 mm	1
7	300.0550	Digital depth gauge 0-25 mm, 125 mm	1
8	300.0114	Tape measure with locking device and belt clip, black red, 5 m, 19 mm	1
9	157.0105	Halfround file, form E, cut 2, 20 mm	1
10	157.0205	Round file, form F, cut 2, 200 mm	1
11	157.0005	Flat file, form B, cut 2, 200 mm	1
12	157.0405	Tri-bastard file, form C, cut 2, 200 mm	1
13	157.0960	Brake saddle file, extra narrow, 270 mm	1
14	911.8138	Trim plastic wedge, 195 mm x B = 30 mm	1
15	907.2115	Hacksaw frame, 300 mm	1
16	907.2166	Snap off blades 0,5 x 1,8 x 100 mm, dispenser with 10 pieces	10
17	907.2135	Universal snap off blade knife 18 mm	1
18	129.6620-24	HSS Bi Co 8 metal high performance saw blades 1,0 mm	1
19	911.8146	Tyre lever, 370 mm	1

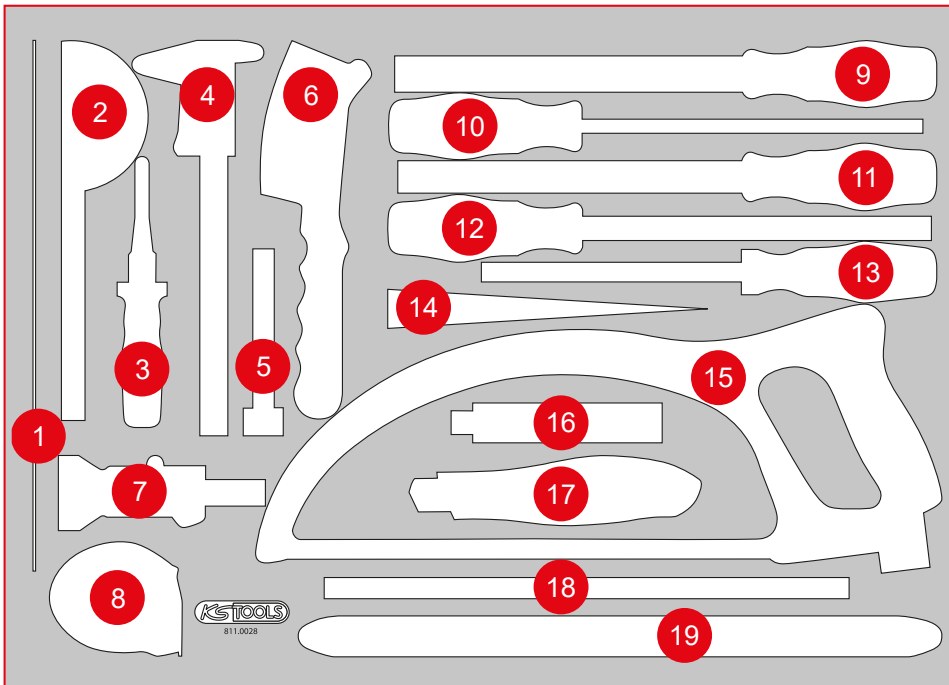

P30

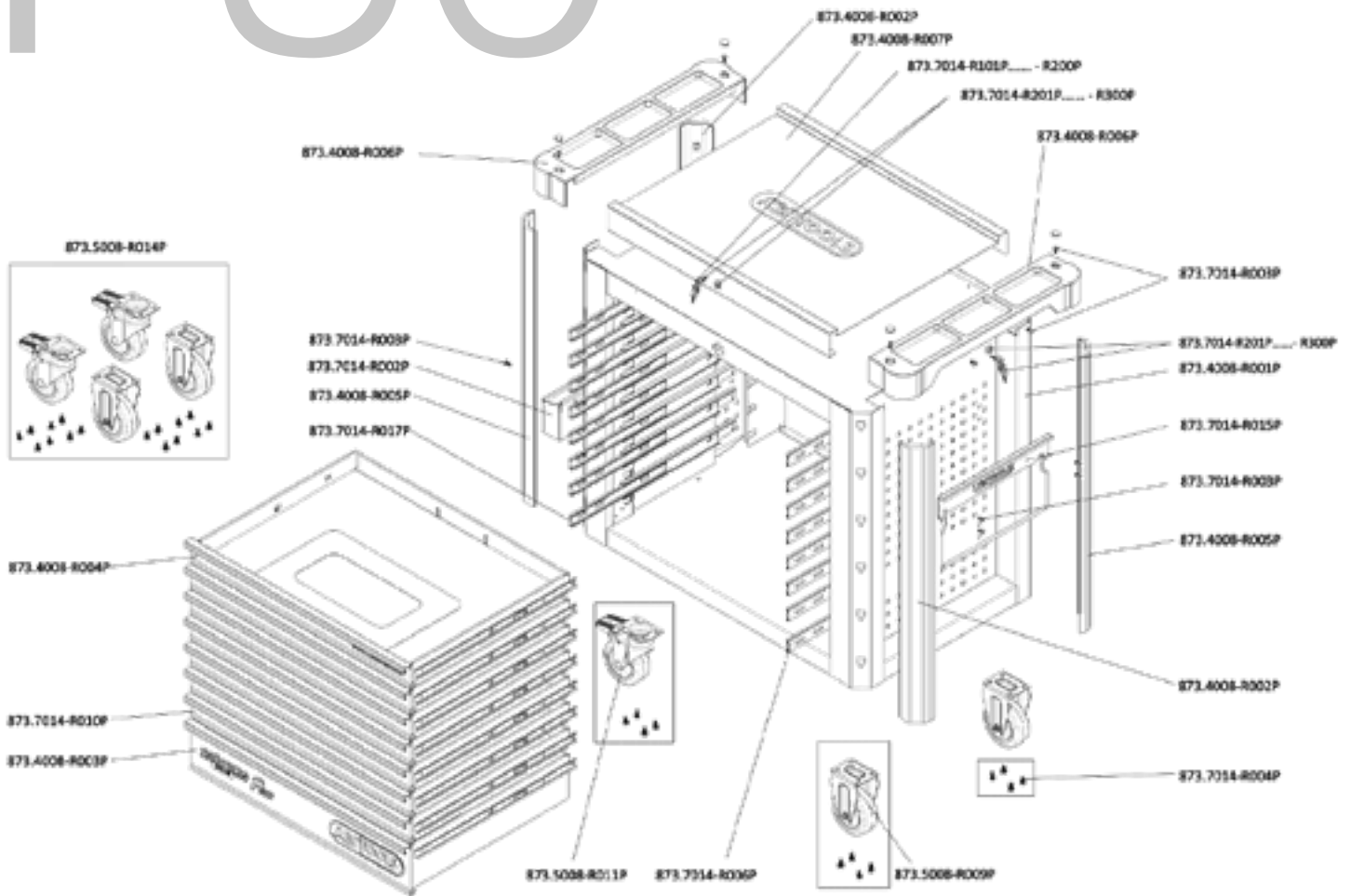

INDIVIDUAL PARTS LIST

Art.-Nr.	Description	amount
873.7014-R101P...	Replacement key for PERFORMANCEplus workshop trolley lock number xyz	2
873.7014-R201P...	Lock with 2 keys for PERFORMANCEplus workshop trolley lock number xyz	2
873.4008-R001P	Body with handle	1
873.4008-R002P	Plastic bumpers	2
873.4008-R003P	Compartment with logo and ball-bearing guide, 785x568x145 mm	1
873.4008-R004P	Compartment with website and ball-bearing guide, for workshop trolley P20/P30, 785x568x65 mm	1
873.4008-R005P	Plastic bumpers	2
873.4008-R006P	Storage for work surface	2
873.4008-R007P	Stainless steel work surface	1
873.5008-R009P	Fixed castors for PERFORMANCEplus workshop trolley, incl. screws	2
873.5008-R011P	Swivel castors with brakes for PERFORMANCEplus workshop trolley, incl. screws	2
873.5008-R014P	Roller set for PERFORMANCEplus workshop trolley, incl. screws	1
873.7014-R002P	Can holder for PERFORMANCEplus workshop trolley P20/P30/P35/P40/P45	1
873.7014-R003P	M6x12 screw (1 pcs.) for PERFORMANCEplus workshop trolley accessories	14
873.7014-R004P	M8 screws for PERFORMANCEplus workshop trolley rollers (16 pcs.)	1
873.7014-R006P	Full extension (with ball-bearing guide) with automatic retraction	8
873.7014-R010P	Compartment with ball-bearing guide, for workshop trolley P20/P30/P45, 785x568x65 mm	6
873.7014-R015P	Paper roll holder for PERFORMANCEplus workshop trolley P20/P30/P35/P40/P45	1
873.7014-R017P	Full extension (with ball-bearing guide) with automatic retraction	8



873.7014-R101P...R200P
Replacement key for lock number xyz



873.7014-R201P...R300P
Lock with 2 keys, lock number xyz



873.7014-R006P
Full extension (with ball-bearing guide) with automatic retraction, right



873.7014-R017P
Full extension (with ball-bearing guide) with automatic retraction, left

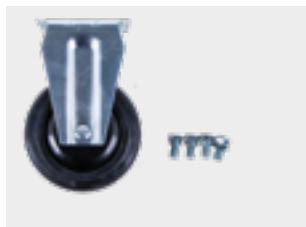

873.5008-R009P
Fixed castors, incl. screws



873.5008-R011P
Swivel castors with brakes, incl. screws



873.5008-R014P
Roller set, incl. screws



873.4008-R007P
Stainless steel work surface



873.4008-R006P
Storage for work surface, including screw cover, usable on both sides



873.4008-R004P
Compartment with website and ball-bearing guide, 785x568x65 mm



873.7014-R010P
Compartment with ball-bearing guide, 785x568x65 mm



873.4008-R003P
Compartment with logo and ball-bearing guide, 785x568x145 mm



873.7014-R002P
Can holder including screws, W = 445 mm



873.7014-R015P
Paper roll holder including screws, W= 400 mm



873.4008-R005P
Plastic bumpers, front left, back right



873.4008-R002P
Plastic bumpers, front right, back left

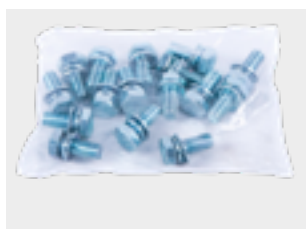

873.7014-R004P
M8 screws (16 pcs.)



873.7014-R003P
M6x12 screw (1 pcs.)



873.4008-R001P
Body of workshop trolley attachment



Strong parts for the great trolley!