

Art. 512.0000

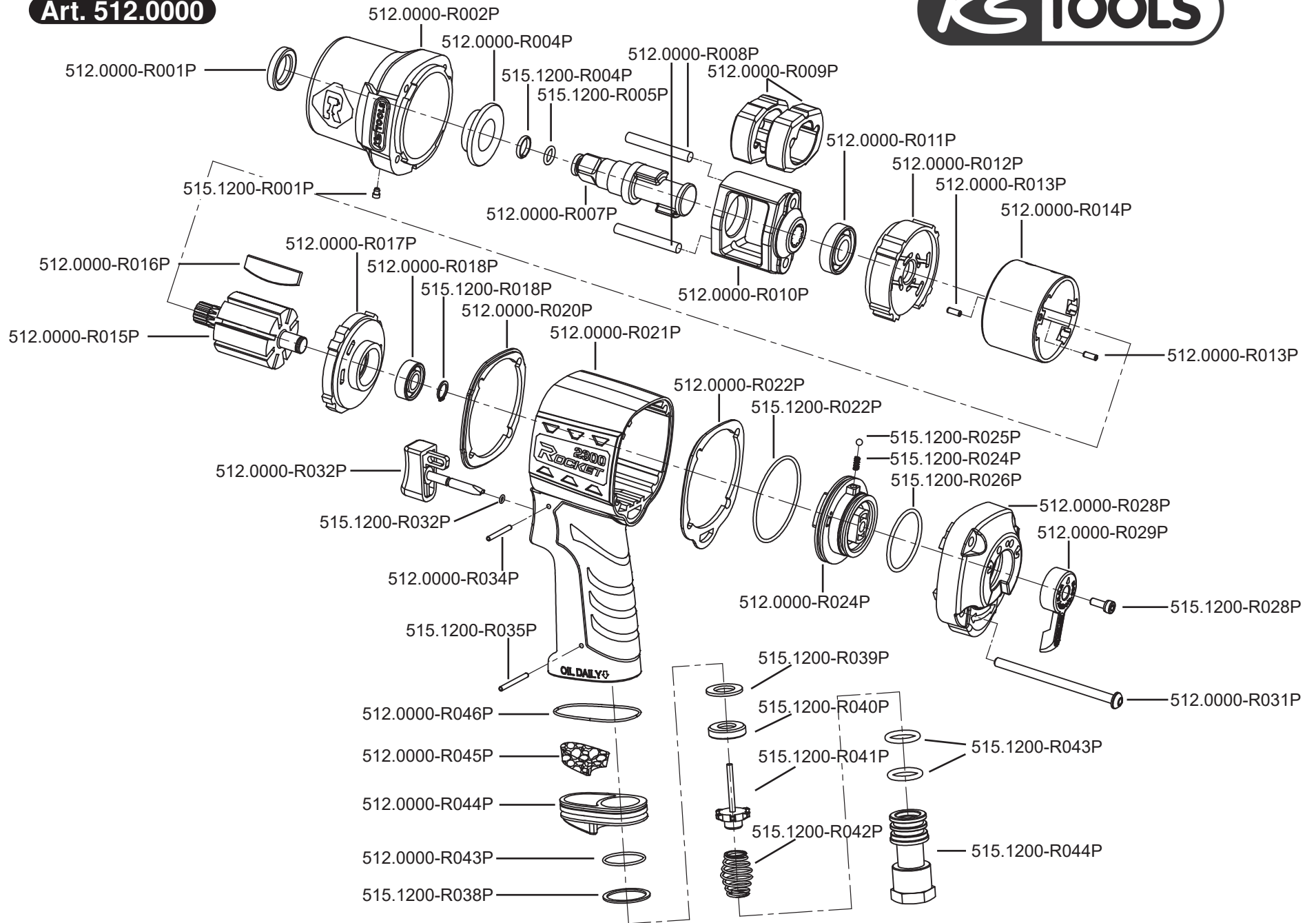

**Art. 512.0000**

Art.-Nr.	Description	Beschreibung	Menge Qty.
512.0000-R001P	Hammer case sealing	Dichtung Hammergehäuse	1
512.0000-R002P	Hammer case	Hammergehäuse	1
512.0000-R004P	Hammer case bushing	Laufbuchse	1
512.0000-R007P	Anvil	Amboss	1
512.0000-R008P	Hammer frame pin	Arretierungsstift	2
512.0000-R009P	Hammer	Hammer	2
512.0000-R010P	Hammer frame	Hammerkäfig	1
512.0000-R011P	Bearing	Kugellager	1
512.0000-R012P	Front end plate	Vordere Verschlussplatte	1
512.0000-R013P	Pin	Pin	2
512.0000-R014P	Cylinder	Rotorgehäuse	1
512.0000-R015P	Rotor	Rotor	1
512.0000-R016P	Blade	Rotorblatt	8
512.0000-R017P	Rear end plate	Verschlussplatte	1
512.0000-R018P	Bearing	Kugellager	1
512.0000-R020P	Front gasket	Vordere Dichtung	1
512.0000-R021P	Housing	Gehäuse	1
512.0000-R022P	Rear cover gasket	Hintere Gehäusedeckeldichtung	1
512.0000-R024P	Reverse valve	Umschaltventil	1
512.0000-R028P	Rear cover	Hintere Gehäuseabdeckung	1
512.0000-R029P	Reverse switch	Umschalthebel	1
512.0000-R031P	End cap screw	Gehäuseschraube	4
512.0000-R032P	Trigger	Betriebsschalter	1

Art.-Nr.	Description	Beschreibung	Menge Qty.
512.0000-R034P	Spring pin	Splint	1
512.0000-R043P	Gasket	Dichtungsring	1
512.0000-R044P	Exhaust deflector	Abluftdeflektor	1
512.0000-R045P	muffler	Abluftdämpfer	1
512.0000-R046P	O-ring	O-Ring	1
515.1200-R001P	Hammer case grease fitting	Schmiernippel	1
515.1200-R004P	Socket retainer	Stecknusshaltering	1
515.1200-R005P	O-ring	O-Ring für Antriebs 4kant	1
515.1200-R018P	Front gasket	Vordere Dichtung	1
515.1200-R022P	O-ring	O-Ring	1
515.1200-R024P	Spring	Feder	1
515.1200-R025P	Steel ball	Stahlkugel	1
515.1200-R026P	O-ring	O-Ring	1
515.1200-R028P	Screw für reverse switch	Schraube für Umschalthebel	1
515.1200-R032P	O-ring	O-Ring	1
515.1200-R035P	Spring pin	Splint	1
515.1200-R038P	Washer	Abluftdichtung	1
515.1200-R039P	Gasket	Dichtungsring	1
515.1200-R040P	Gasket	Dichtungsring	1
515.1200-R041P	Tip valve	Druckventil	1
515.1200-R042P	Valve spring	Ventilfeder	1
515.1200-R043P	O-ring	O-Ring	2
515.1200-R044P	Air inlet	Lufteinlassschraube	1